

Lattice Wave Digital Filters

Lattice wave digital filters are derived from analog lattice filters. The impedances Z_1 and Z_2 are in practice lossless reactances.

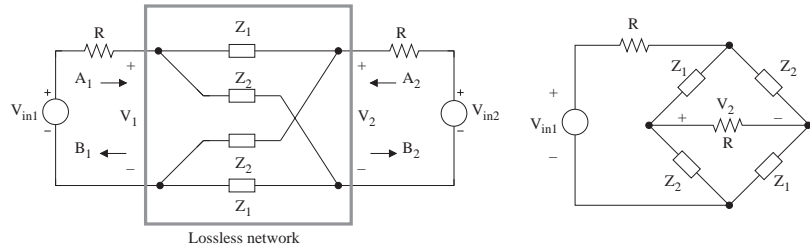

Note that the lattice structure is in fact a bridged structure. Thus, the lattice structure is extremely sensitive to element errors in the stopband.

The lattice structure can be described by the incident and reflected waves

$$A_1 = V_1 + RI_1 = V_{in1} \quad , \quad B_1 = V_1 - RI_1$$

$$A_2 = V_2 + RI_2 = V_{in2} \quad , \quad B_2 = V_2 - RI_2$$

while the lossless network is described by the scattering matrix, \mathcal{S} .

$$\begin{bmatrix} B_1 \\ B_2 \end{bmatrix} = \mathcal{S} \begin{bmatrix} A_1 \\ A_2 \end{bmatrix} = \begin{bmatrix} S_{11} & S_{12} \\ S_{21} & S_{22} \end{bmatrix} \begin{bmatrix} A_1 \\ A_2 \end{bmatrix}$$

After elimination of voltages and currents we get

$$B_1 = 0.5[S_1(A_1 - A_2) + S_2(A_1 + A_2)]$$

$$B_2 = 0.5[S_1(A_2 + A_1) + S_2(A_1 + A_2)]$$

where

$$S_{11} = S_{22} = 0.5(S_2 + S_1)$$

$$S_{21} = S_{12} = 0.5(S_2 - S_1)$$

and

$$S_1 = \frac{Z_1 - R}{Z_1 + R} \quad \text{and} \quad S_2 = \frac{Z_2 - R}{Z_2 + R}$$

In practice, the impedances Z_1 and Z_2 are pure reactances. Hence, the corresponding reflections, S_1 and S_2 are allpass functions.

Note that the lattice wave digital filter (LWDF) consists of two allpass filters in parallel.

LWDFs have low sensitivity in the passband, but very high sensitivity in the stopband.

It can be shown that the filter order must be odd for lowpass filters and that the transfer function must have an odd number of zeros at $z = \pm 1$ for bandpass filters.

The two transfer functions are power-complementary

$$|H(e^{j\omega T})|^2 + |H_c(e^{j\omega T})|^2 = 1$$

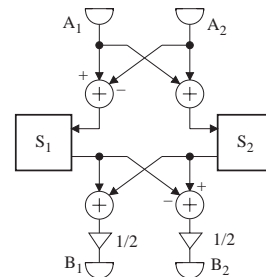

Several methods can be used to realize canonic reactances, for example:

1. Classical LC structures

Foster I and II

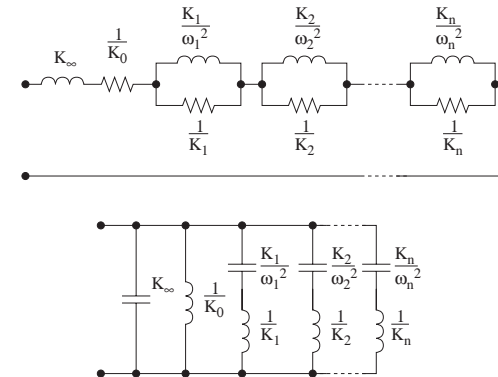

Cauer I and II

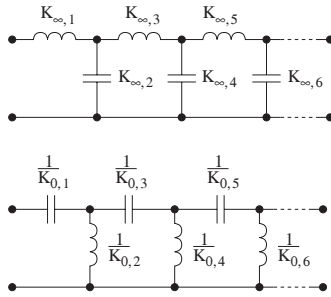

2. Cascaded unit elements—Richards' structures

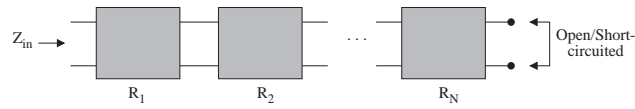

First-order Richards' structures

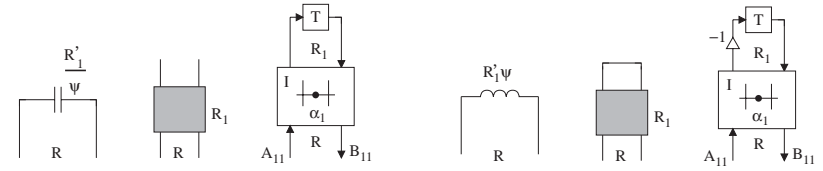

The reflectance corresponding to a single open-ended unit element is

$$S(z) = \frac{-\alpha_0 z + 1}{z - \alpha_0} \text{ where } \alpha_0 = \frac{R - R_1}{R + R_1}$$

and for a short-circuited unit element

$$S(z) = \frac{\alpha_0 z + 1}{z + \alpha_0} \text{ where } \alpha_0 = \frac{R - R_1}{R + R_1}$$



Second-order Richards' structures

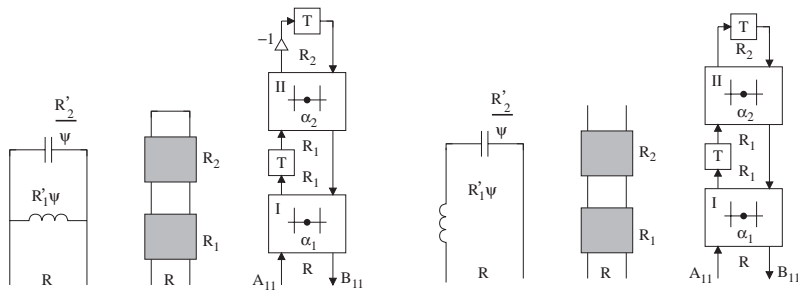

The reflectance for the parallel resonance circuit is

$$S(z) = \frac{\alpha_1 z^2 + \alpha_2(1 + \alpha_1)z + 1}{z^2 + \alpha_2(1 + \alpha_1)z + \alpha_1} \text{ (allpass function)}$$

$$\alpha_1 = \frac{R - R_1}{R + R_1} \text{ and } \alpha_2 = \frac{R_1 - R_2}{R_1 + R_2}$$



3. Circulator structures

Higher-order reflectances can also be obtained by connecting circulators loaded with reactances.

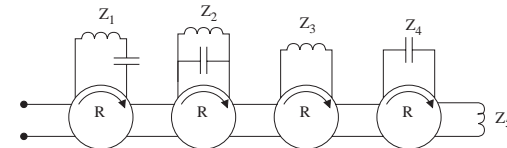

The combined reflectance is

$$S = (-S_1)(-S_2)(-S_3)(-S_4)(-S_5)$$

$$S_n = \frac{Z_n - R}{Z_n + R}$$



Example

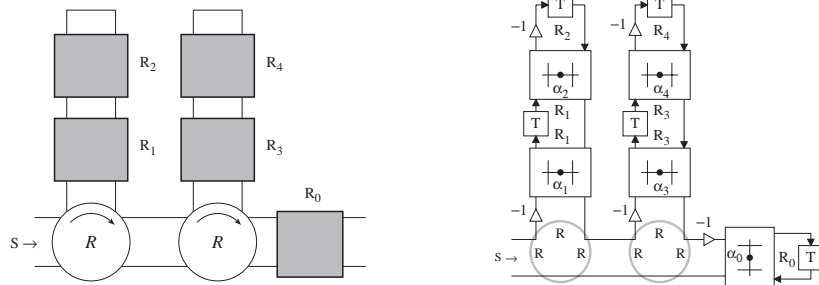

The resulting reflectance mapped to the z -plane using the bilinear transformation is

$$S = -\frac{-\alpha_0 z + 1}{z - \alpha_0} \cdot \frac{\alpha_1 z^2 + \alpha_2(1 + \alpha_1)z + 1}{z^2 + \alpha_2(1 + \alpha_1)z + \alpha_1} \cdot \frac{\alpha_3 z^2 + \alpha_4(1 + \alpha_3)z + 1}{z^2 + \alpha_4(1 + \alpha_3)z + \alpha_3}$$

Characteristics of lattice wave digital filters are

- + The filter order (lowpass): $\deg\{H\} = \deg\{Z_1\} + \deg\{Z_2\} = \text{odd}$.
- + Number of multiplications = number of delay elements = $\deg\{H\}$.
- + Passband sensitivity is even better than for ladder structures.
- + Possesses a high degree of computational parallelism and can be pipelined.
- + Simple modular building blocks are possible.
- + Simple to design.

– Very high stopband sensitivity. However, this causes not a serious problem in a digital implementation.



Design of Lattice Wave Digital Filters

- Design of an analog lattice filter (reference filter) that is mapped to a wave digital filter

Short cut

We know that the LWDF consist of two allpass branches.

One of odd order and the other of even order.

It can be shown that the poles in the analog reference filter maps to the branches as shown. Blue = odd branch and red = even branch.

The branches can be realized by any of the methods discussed above.

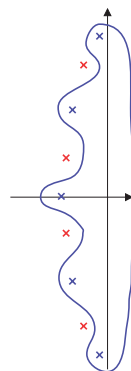

11



Example 4.11

Design a digital lowpass filter of Caer type, with $A_{max} = 0.01$ dB, $f_c = 10$ kHz, $A_{min} = 65$ dB, $f_s = 20$ kHz, and $f_{sample} = 250$ kHz.

We modify the specification to explore the design margin

```
fc = 10;
fs = 18;
fsample = 250;
Amax = 0.0039069;
Amin = 72.9885;
Wc = tan(fc*pi/fsample);
Ws = tan(fs*pi/fsample);
N = CA_LP_Order(Wc, Ws, Amax, Amin)
N = 7% We select the next higher odd order
[Z, P, G] = CA_LP_Poles(Wc, Ws, Amax, Amin, N);
yields N = 7

Ps =
-0.0755 - 0.0755i
-0.0755 + 0.0755i
-0.0437 - 0.1228i
-0.0437 + 0.1228i
-0.0136 - 0.1426i
-0.0136 + 0.1426i
-0.0912

Zs =
0 - 0.4943i
0 + 0.4943i
0 - 0.2848i
0 + 0.2848i
0 - 0.2351i
0 + 0.2351i
∞
```

12



Nest, sort the poles and zeros into the odd and even branches

$$\begin{array}{l} P_{s_odd} = \\ -0.0437 - 0.1228i \\ -0.0437 + 0.1228i \\ -0.0912 \end{array} \quad \begin{array}{l} P_{s_even} = \\ -0.0755 - 0.0755i \\ -0.0755 + 0.0755i \\ -0.0136 - 0.1426i \\ -0.0136 + 0.1426i \end{array}$$

Map the poles to the z-plane using the bilinear transformation

$$\begin{array}{l} P_{z_odd} = \\ 0.8902 - 0.2225i \\ 0.8902 + 0.2225i \\ 0.8329 \end{array} \quad \begin{array}{l} P_{z_even} = \\ 0.8506 - 0.1298i \\ 0.8506 + 0.1298i \\ 0.9348 - 0.2722i \\ 0.9348 + 0.2722i \end{array}$$

Identifying the adaptor coefficient using to poles and the reflectances for a

$$\text{first-order section } S(z) = \frac{-\alpha_0 z + 1}{z - \alpha_0}.$$

$$\text{and the second-order sections } S(z) = \frac{\alpha_1 z^2 + \alpha_2(1 + \alpha_1)z + 1}{z^2 + \alpha_2(1 + \alpha_1)z + \alpha_1}$$



$$\begin{array}{ll} H_0: & \alpha_0 = 0.832865 \\ H_3: & \alpha_3 = 0.841873 \quad \alpha_4 = -0.966577 \\ H_1: & \alpha_1 = 0.740330 \quad \alpha_2 = -0.977482 \\ H_5: & \alpha_5 = 0.947965 \quad \alpha_6 = -0.959780 \end{array}$$

where $|\alpha_i| < 1$

The transfer function is

$$H(z) = H_2(z)H_3(z) - H_0(z)H_1(z)$$

where $H_0(z)$ is a first-order allpass section while the other sections are second-order allpass sections.

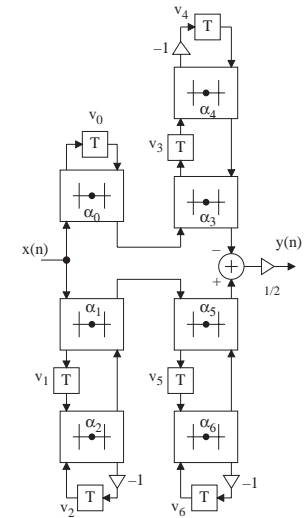

$$H(z) = \frac{1}{2} \frac{\alpha_1 z^2 + \alpha_2(1 + \alpha_1)z + 1}{z^2 + \alpha_2(1 + \alpha_1)z + \alpha_1} \cdot \frac{\alpha_5 z^2 + \alpha_6(1 + \alpha_5)z + 1}{z^2 + \alpha_6(1 + \alpha_5)z + \alpha_5} + \frac{1}{2} \frac{-\alpha_0 z + 1}{z - \alpha_2} \cdot \frac{\alpha_3 z^2 + \alpha_4(1 + \alpha_3)z + 1}{z^2 + \alpha_4(1 + \alpha_3)z + \alpha_3}$$

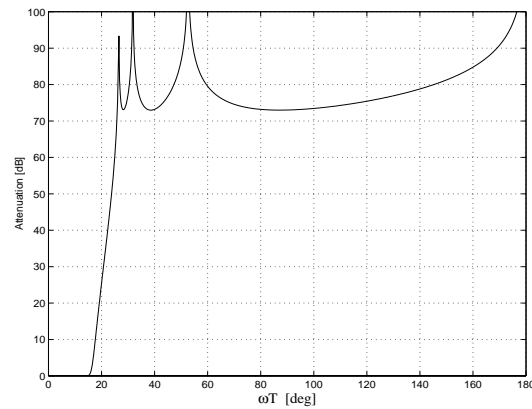

Bireciprocal Lattice Wave Digital Filters

Significant simplifications of the digital filter algorithm can be made if the magnitude functions $|S_{11}(e^{j\omega T})|$ and $|S_{21}(e^{j\omega T})|$ are antisymmetric around $\pi/2$.

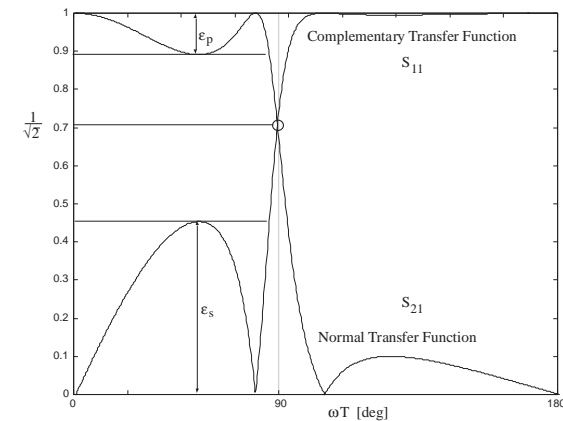

Lattice wave digital filters of this type are called *bireciprocal filters*.

The attenuation is always 3.01 dB at $\omega T = \pi/2$. These filters are also referred to as *half-band IIR filters* or *power-complementary filters*.

We must have

$$\epsilon_p = \frac{1}{\epsilon_s}$$

where

$$A_{max} = 10 \log(1 + \epsilon_p^2) \tag{4.19}$$

$$A_{min} = 10 \log(1 + \epsilon_s^2) \tag{4.20}$$

Note that high attenuation in the stopband yields **VERY** low attenuation in the passband. Furthermore we must have

$$\omega_c T = \pi - \omega_s T$$



Bireciprocal lattice WDFs are highly efficient for decimation and interpolation of the sample frequency by a factor of two.

The primary motivation for using half-band filters is the dramatically reduced computational complexity.



Example 4.12

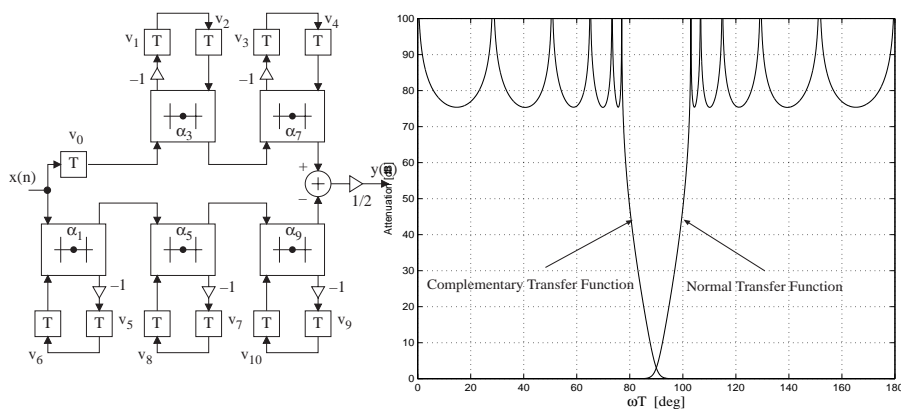

The poles of a half-band filter lie on the imaginary axis in the z -plane.

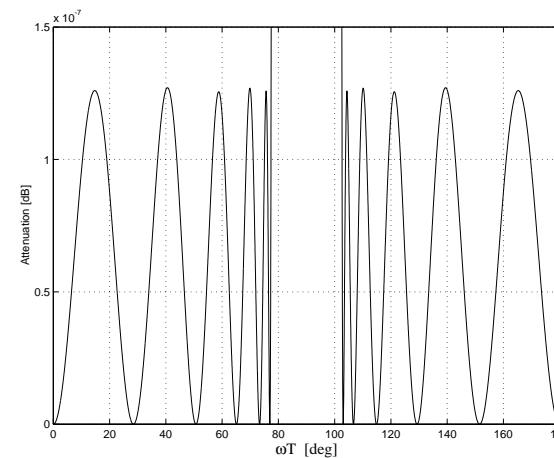

The number of adaptors and multipliers is only $(N-1)/2$ and the number of adders is $3(N-1)/2 + 1$ for this type of filter (N is always odd).

Only bireciprocal WDFs of Butterworth and Cauer types are possible.

