

WAVE DIGITAL FILTERS

1

WAVE DESCRIPTIONS

Wave digital filter theory is based on a scattering parameter formalism. The one-port network can be described by the incident and reflected waves instead of voltages and currents.

The steady-state voltage waves are defined as

$$\begin{cases} A \stackrel{D}{=} V + RI \\ B \stackrel{D}{=} V - RI \end{cases}$$

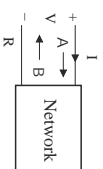

where A is the *incident wave*, B is the *reflected wave*, and R is a positive real constant, called port resistance.

A one-port can be described by the *reflectance function*, defined as

$$S \stackrel{D}{=} \frac{A}{B}$$



Example

Determine the reflectance for an impedance Z .

The voltage waves are

$$\begin{cases} A = V + RI \\ B = V - RI \end{cases}$$

and the impedance is described by: $V = ZI$. We get

$$S = \frac{Z - R}{Z + R}$$

Reflectance is an allpass function for a pure reactance.



2

3

It is not possible to directly use reference filters with lumped circuit elements, since nonsequentially computable algorithms are obtained.

Instead certain classes of transmission line filters must be used.

Fortunately, some of these filter structures can be mapped to classical filter structures with lumped circuit elements and we can make full use of the abundant knowledge of lumped element filters.

Transmission Lines

4

A special case of filter networks with distributed circuit elements is *commensurate-length* transmission line filters in which all lines have a common electrical propagation time.

A *lossless transmission* line can be described as a two-port by the chain matrix

$$\begin{bmatrix} V_1 \\ I_1 \end{bmatrix} = \frac{1}{\sqrt{1 - \tanh^2 \frac{2\ell s t^*}{2}}} \begin{bmatrix} 1 & Z_0 \tanh \frac{\ell s t^*}{2} \\ \frac{1}{Z_0} \tanh \frac{\ell s t^*}{2} & 1 \end{bmatrix} \begin{bmatrix} V_2 \\ -I_2 \end{bmatrix}$$

where Z_0 is the characteristic impedance and $t/2$ is the propagation time in each direction.

Z_0 is a real positive constant, ($Z_0 = R$), for lossless transmission lines and is therefore sometimes called the characteristic resistance, while lossless transmission lines are often referred to as *unit elements*.



Obviously, a transmission line cannot be described by poles and zeros since the elements in the chain matrix are not rational functions in s .

Wave digital filters imitate reference filters built out of resistors and lossless transmission lines by means of incident and reflected voltage waves.

Computable digital filter algorithms can be obtained if the reference filter is designed using only such transmission lines.

Wave digital filter design involves synthesis of such reference filters.

Commensurate-length transmission line filters constitute a special case of distributed element networks that can easily be designed by mapping them to a lumped element structure.



This mapping involves *Richards' variable* which is defined as

$$Y = D \frac{e^{sT} - 1}{e^{sT} + 1} = \tanh \frac{fsT}{2}$$

where $Y = \hat{A} + jW$. Richards' variable is a dimensionless complex variable.

The real frequencies in the s - and Y -domains are related by

$$W = \tan \frac{f\omega T}{2}$$

Notice the **similarity between the bilinear transformation and Richards' variable**. Substituting Richards' variable into the chain matrix yields

$$\begin{bmatrix} Y_1 \\ I_1 \end{bmatrix} = \frac{1}{\sqrt{1-Y^2}} \begin{bmatrix} 1 & Z_0 Y \\ Y & 1 \end{bmatrix} \begin{bmatrix} Y_2 \\ -I_2 \end{bmatrix}$$



The chain matrix above has element values that are rational functions in Richards' variable, except for the square-root factor.

Fortunately, this factor can be handled separately during the synthesis. The synthesis procedures (programs) used for lumped element design can therefore be used with small modifications in the synthesis of commensurate-length transmission line filters.

The transmission line filters of interest are, with a few exceptions, built using only one-ports.



The input impedance of the transmission line, with characteristic impedance Z_0 , loaded with an impedance Z_2 is

$$Z_{in}(\gamma) = \frac{Y_1}{I_1} = \frac{Z_2 + Z_0 Y}{Z_0 + Z_2 Y} Z_0$$

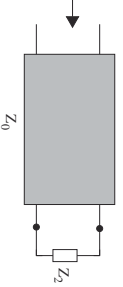

The input impedance of a lossless transmission line with characteristic impedance $Z_0 = R$ that is terminated by an impedance Z_2 is

$$Z_2 = R \text{ (matched termination)} \quad Z_{in}(\gamma) = \frac{Z_2 + R Y}{R + Z_2 Y} R = R$$

$$Z_2 = \infty \text{ (open-ended)} \quad Z_{in}(\gamma) = \frac{Z_2 + R Y}{R + Z_2 Y} R = \frac{R}{Y}$$

$$Z_2 = 0 \text{ (short-circuited)} \quad Z_{in}(\gamma) = \frac{Z_2 + R Y}{R + Z_2 Y} R = R Y$$



Transmission Line Filters

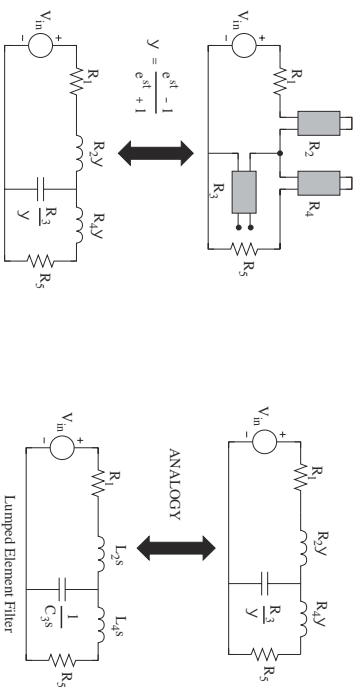

Wave-Flow Building Blocks

The input impedance to an open-circuited unit element (a Y-domain capacitor) with $Z_0 = R$ is

$$Z_{in}(\gamma) = \frac{R}{\gamma}$$

We get the reflectance

$$S(\gamma) = \frac{Z_{in} - R}{Z_{in} + R} = \frac{1 - \gamma}{1 + \gamma} = e^{-st}$$

and

$$S(z) = z^{-1}$$

The input impedance to a short-circuited unit element (a Y-domain inductor) with $Z_0 = R$ is

$$Z_{in}(\gamma) = R\gamma$$



The reflectance is

$$S(\gamma) = \frac{Z_{in} - R}{Z_{in} + R} = \frac{\gamma - 1}{1 + \gamma} = -e^{-st}$$

11

and

$$S(z) = -z^{-1}$$

The reflectance for a unit element terminated at the far end by a resistor with $Z_0 = R$ (matched) is

$$S(\gamma) = \frac{Z_{in} - R}{Z_{in} + R} = 0$$

Hence, an input signal to such a unit element is not reflected. The corresponding wave-flow equivalent is a wave sink.

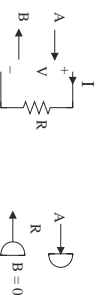

The corresponding wave-flow graphs to a short-circuit an open-circuit are

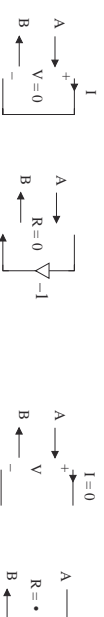

12

Interconnection Networks

In order to interconnect different wave-flow graphs, it is necessary to obey Kirchoff's laws at the interconnection. Generally, at a point of connection, the incident waves are partially transmitted and reflected. Transmission and reflection at the connection point are described by a wave-flow graph called an *adaptor*.

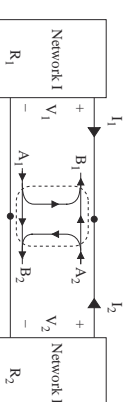

Symmetric Two-Port Adaptor

The symbol for the symmetric two-port adaptor that corresponds to a connection of two ports.

The incident and reflected waves for the two-port are

$$\begin{cases} A_1 \\ B_1 \end{cases} \begin{cases} I_1 = Y_1 + R_1 I_1 \\ I_1 = Y_1 - R_1 I_1 \end{cases} \quad \text{and} \quad \begin{cases} A_2 \\ B_2 \end{cases} \begin{cases} I_2 = Y_2 + R_2 I_2 \\ I_2 = Y_2 - R_2 I_2 \end{cases}$$

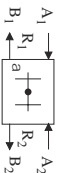

At the interconnection we have, according to Kirchoff's current and voltage laws

$$\begin{cases} I_1 = -I_2 \\ 0 I_1 = Y_2 \end{cases}$$

By eliminating voltages and currents we get the following relation between incident and reflected waves for the *symmetric two-port adaptor*

$$\begin{cases} B_1 = A_2 + a(A_2 - A_1) \\ B_2 = A_1 + a(A_2 - A_1) \\ a = \frac{R_1 - R_2}{R_1 + R_2} \end{cases}$$

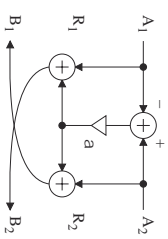

The adaptor coefficient a is usually written on the side corresponding to port 1. As can be seen, the wave-flow graph is almost symmetric.

Note that $a = 0$ for $R_1 = R_2$. The adaptor degenerates into a direct connection of the two ports and the incident waves are not reflected at the point of interconnection.

For $R_2 = 0$ we get $a = 1$ and the incident wave at port 1 is reflected and multiplied by -1 while for $R_2 = \infty$ we get $a = -1$ and the incident wave at port 1 is reflected without a change of sign.



Design of Wave Digital Filters

